

halide lyon

ficha técnica

datasheet

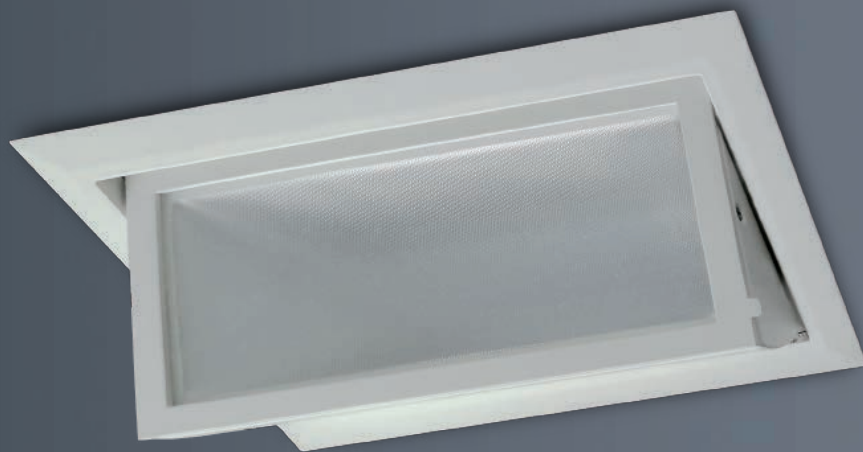

ref. 5551273

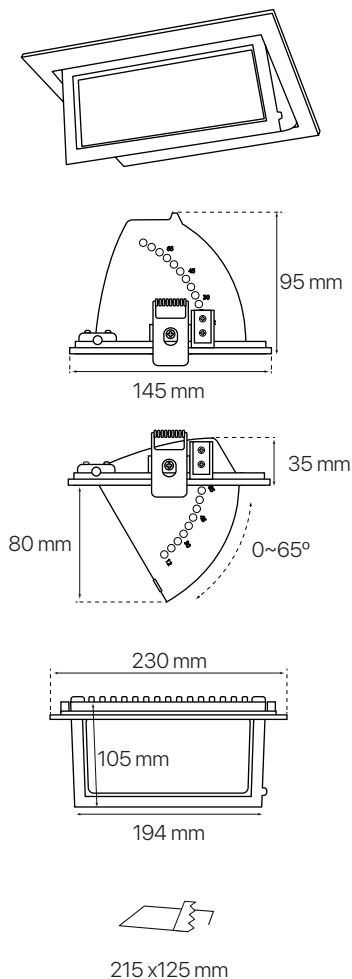

Nombre / Name	halide Lyon
Referencia / Reference	5551273
Materiales / Materials	Aluminio + Cristal / Aluminum + Glass
Difusor / Diffuser	Cristal Prismático / Prismatic Crystal
Potencia / Power	50W
Temperatura de color / Color temperature	4000K
Flujo luminoso / Luminous flux	5100 lm
Dimable / Dimmable	-
Ángulo de apertura / Beam angle	90°
Ángulo de inclinación / Inclination angle	65°
IP	IP20
IK	08
F.P	>0.9
UGR	<20
IRC	>80
Chip	PHILIPS SMD 3030
Driver	PHILIPS XITANIUM
Vida media (duración) / Average life	± 50.000 h
Clase energética / Energy class	A+
Aislamiento eléctrico / Electrical isolation	Clase II / Class II
Colores / Colors	Blanco / White
Medida exterior / Product size	230 mm x 145mm x 95 mm
Medidas de corte / Cutting measurements	215 mm x 125 mm
Tª (ambiente/trabajo) / Tª (environment/work)	-20°C ~ +50°C
Input	AC 220 ~ 240V
Output	DC 30 ~ 42V 1200mA ±5%
Frecuencia / Frequency	50 / 60Hz
Peso / Weight	1,28 Kg
Certificados / Certificates	CE RoHS
Garantía / Warranty	2 años / 2 years